



## SWIM COLLECTION



———— 2019 ————  
**OWNER'S MANUAL**

2100VE/2101VE

Coast Spas Manufacturing Inc.  
6315 202 Street, Langley BC Canada  
604 514 8111  
[info@coastspas.com](mailto:info@coastspas.com)  
[www.coastspas.com](http://www.coastspas.com)

**TABLE OF CONTENTS**

<b>Table of Contents</b>	<i>Page</i>	<b>2</b>
<b>Safe Handling / Unloading Instructions</b>	<i>Page</i>	<b>3</b>
<b>Basic Information</b>	<i>Page</i>	<b>4</b>
<b>Quick Start Guide</b>	<i>Page</i>	<b>5</b>
<b>Important Safety Instructions</b>	<i>Page</i>	<b>6</b>
<b>Preparation and Set-up for Your New Spa</b>	<i>Page</i>	<b>7</b>
<b>Electrical Requirements</b>	<i>Page</i>	<b>7</b>
<b>Draining &amp; Winterizing</b>	<i>Page</i>	<b>7-8</b>
<b>Filter Maintenance</b>	<i>Page</i>	<b>9</b>
<b>Water Quality Maintenance</b>	<i>Page</i>	<b>9-10</b>
<b>Water Clarity Troubleshooting</b>	<i>Page</i>	<b>11</b>
<b>Product &amp; Care Guide</b>	<i>Page</i>	<b>12-13</b>
<b>Glossary of Terms</b>	<i>Page</i>	<b>13-14</b>
<b>Basic Installation and Configuration Guidelines</b>	<i>Page</i>	<b>14</b>
<b>Troubleshooting Guide</b>	<i>Page</i>	<b>15-16</b>
<b>Spa Controls</b>	<i>Page</i>	<b>17-20</b>
<b>PRV19 Instructions</b>	<i>Page</i>	<b>21</b>
<b>DM6 Instructions</b>	<i>Page</i>	<b>22-23</b>
<b>Ozone Instructions</b>	<i>Page</i>	<b>24</b>
<b>Letter from Coast Spas Manufacturing Inc.</b>	<i>Page</i>	<b>25</b>

**IMPORTANT GFCI INFORMATION**

Based on the testing conducted by the supplier of the true variable speed pumps, the Siemens brand GFCI can filter electrical spikes and avoid false trips. The use of a 60 Amp Siemens GFCI is recommended with the Atlas Swim System.



## SAFE HANDLING / UNLOADING INSTRUCTIONS

### CAUTION!



- Use 6" wide straps that are at least 30 feet in length to support the base of the spa during lifting.
- Ensure the straps are in good working condition prior to unloading the spa (ie. No rips, wear or tear)
- Ensure the straps are evenly spaced at 66" from each end (see diagram below). Spacing the straps may require slight adjustments to ensure the load is balanced.
- The chains attached to the crane must be a minimum of 18 feet in length from the point of lifting. Using chains smaller than 18 feet will add stress to the outer lip of the spa and may result in damage.
- Using the appropriately weighted straps and chains is important to ensure the safe handling of the 2100 VE Spa. Please consult your crane operator for more information.

**Note:** Damage during transportation or from mishandling or improper lifting is not covered by the CSMI Warranty.

**Note:** Never lift or handle the spa by the plumbing or equipment.

### 2100 VE

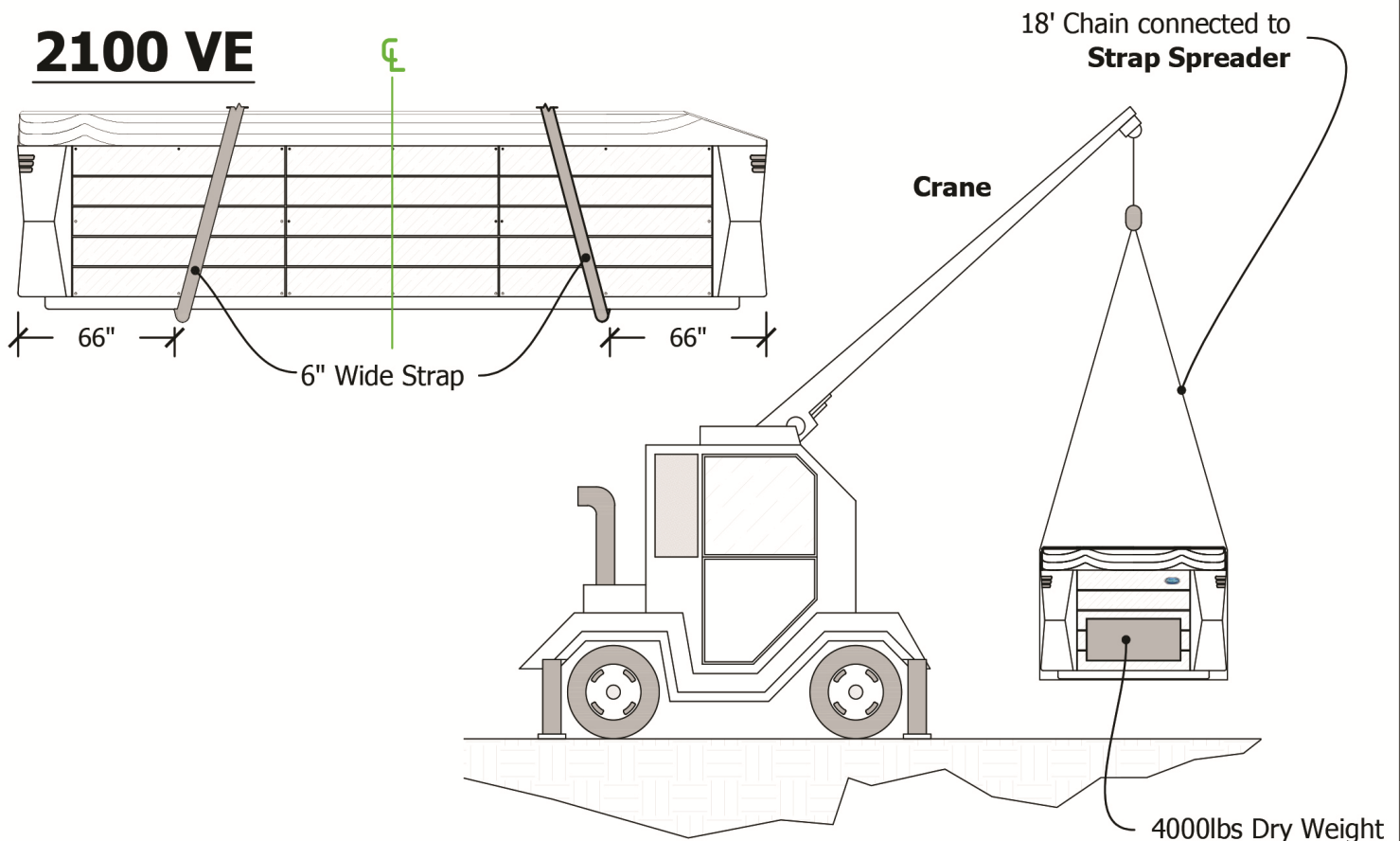



## CONGRATULATIONS!

YOU'RE ALMOST READY TO ENJOY YOUR NEW SPA!

**! PLEASE READ YOUR ENTIRE OWNER'S MANUAL BEFORE SPA OPERATION !**

### Basic Information

#### Water Care

**IMPORTANT:** Caring for your water by ensuring proper chemical usage is the single most important thing you can do to keep your hot tub in good condition.

**WARNING:** Improper chemical usage and maintenance will quickly lead to severe issues with your spa and can effect the spas equipment, jets, pumps and all other components in contact with the spa water. **All hot tubs and swim spas are susceptible to damage from unbalanced spa water.**

Always maintain your spa's water chemistry within the following parameters:

pH	7.2 - 7.8
Chlorine	1.0 - 3.0 ppm
Bromine	2.0 - 5.0 ppm
Total Alkalinity	100 - 120 ppm
Calcium Hardness	150 - 250 ppm

#### Electrical

**All self contained spas use 120VAC or 240VAC electrical spa packs.**

**120VAC:** Requires an isolated 15Amp circuit breaker, an isolated circuit with no other appliances or lights on the circuit at any time. Extension cords are not to be used in conjunction with the operations of the spa. Low voltage damage could result and this is not covered by warranty.

**IMPORTANT: Hot Tubs with 110V means that the jets and heater will not work at the same time.**

*NOTE: All components must be 120V. No 240V components allowable.*

**240VAC:** Depending on the model of spa, it will require either a 40, 50 or 60 Amp dedicated circuit breaker with the proper wire size (gauge) based on the length of the run.

**The electrical circuit must be installed by a certified electrician and approved by a local building or electrical inspector.**

#### Surface

Your new portable spa must be placed on a firm, flat and level surface, so the spa weight is supported uniformly. We recommend no less than a 3" (93 mm) thick concrete slab. Wood decking or balconies must be constructed to support 150 pounds per square foot (730 kg/m<sup>2</sup>). Refer to local and current building codes in your area. Consult an engineer for live loads in your area. Should your new spa need to go through a gate or space-restrictive area, ensure you've communicated those limitations with your dealer to avoid delivery complications.

*NOTE: Damage caused by alternate decking methods may avoid the spa warranty. Contact your dealer if you have any questions regarding spa location or placement.*

#### Transport

Your new spa has left the factory cleaned and polished and ready to begin operation after passing our many quality and operational tests. However, depending on your location in the world, your spa may have spend days or even weeks in transit before arriving at your home. Please ensure that before filling or operating your hot tub that you check all electrical and plumbing connections are securely connected in the equipment area as they might have loosened during shipping. If any dirt has accumulated, you will want to remove with a clean cloth or sponge using warm water.



# START UP GUIDE

## 2100/2101 VE SWIM SPAS

### PREP FOR FILLING

**! PLEASE READ ALL INSTRUCTIONS BELOW BEFORE FILLING THE SPA**



Using a cloth and water, wipe away any dirt/dust collected from transport. Ensure all jets are open by turning the face counter clockwise.

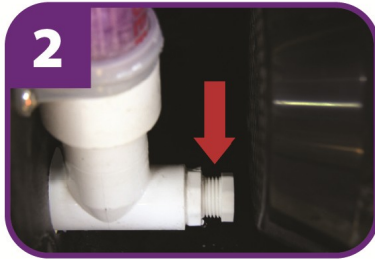

If your spa has a Crystal Clear tube the threaded plug needs to be on prior to filling the spa.



Remove the filter lock ring and lid. Remove filter and take it out of the plastic transport bag.



Put the filter back inside and secure the lid firmly with the locking ring. Loosen air-bleed screw.

### FILLING YOUR SPA

**! DO NOT USE HOT WATER TO FILL YOUR SPA**

**! DO NOT USE WATER FROM A WATER SOFTENER**



Place fill hose inside the spa and fill main body of spa with water until it reaches the infinity edge. Allow water to spill over infinity edge for approximately 60 seconds.



Tighten air-bleed screw.



Turn power to the spa on from GFCI breaker to activate water level gauge. Continue filling until the water gauge reads just above 3/4 full.



Turn power to the spa off from the GFCI breaker for 30 seconds and then turn back on.

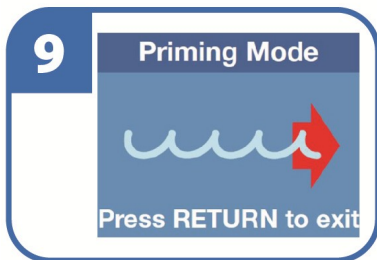

Press the return/pump 5 button to exit the priming mode, pump 1 will automatically start. Turn pump 1 off by pressing the pump 1 button twice.



Turn pump 2 on; once pump 2 is running make sure all the air is removed from the check valve. Press the pump 1 button twice to turn pump 1 into high speed. The check valve will pull air in. You will then turn pump 1 off.

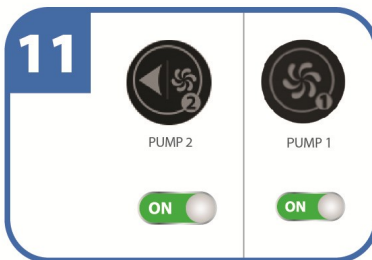

Continue running pump 2, once the check valve is full of water turn pump 1 onto high speed by pressing the pump 1 button twice, then turn off by pressing pump 1 once. Repeat this step 3-4 times until all the air is removed from the check valve.



Cascade check valve inside the equipment area, full of water is an indication of no more air in the plumbing line. If the check valve is not full of water, air is still in the plumbing lines.



Release any additional trapped air by loosening the air bleed screw. Wait for all air to be released. Retighten.

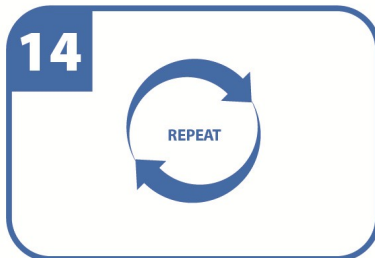

Repeat steps 11-12 until all air has been removed from the system. If air is still in the system it will precede water coming out of the jets when pump 1 is activated.

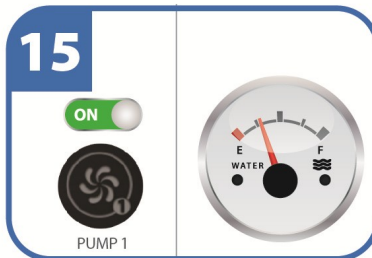

Your water level should read just above 1/4 on the gauge when pump 1 (high speed) is activated. **Your hot tub is now filled. Set the temperature and get ready to enjoy!**

## IMPORTANT SAFETY INSTRUCTIONS

### READ AND FOLLOW ALL INSTRUCTIONS CAREFULLY

**DANGER:** Risk of Injury. The suction fittings in this hot tub are sized to match the specific water flow created by the pump. Should the need arise to replace the suction fittings or the pump, be sure that the flow rates are compatible. Never operate the hot tub if the suction fittings are broken or missing. Never replace a suction fitting with one rated less than the flow rate marked on the original suction fitting.

**DANGER:** Risk of Accidental Drowning. Do not allow children to be in or around the spa without adult supervision. Keep the spa cover on and locked when not in use. See instructions enclosed with the cover for locking procedures.

**DANGER:** Risk of Electrical Shock. The electrical supply for this product must include a suitably rated switch or circuit breaker to open all ungrounded supply conductors to comply with section 422-20 of the National Electrical Code, ANSI/NFPA 70. The disconnect must be readily accessible and visible to the hot tub occupant but installed at least 5 feet (1.5 m) from the hot tub water.

### READ, FOLLOW AND SAVE THESE INSTRUCTIONS

a) A green colored terminal or a terminal marked G, Gr, Ground, Grounding or the symbol \* is located inside the supply terminal box or compartment. To reduce the risk of electric shock, this terminal must be connected to the grounding means provided in the electric supply service panel with a continuous copper wire equivalent in size to the circuit conductors that supply this equipment.

b) At least two lugs marked "Bonding Lugs" are provided on the external surface or on the inside of the supply terminal box compartment. To reduce the risk of electric shock, connect the local common bonding grid in the area of the hot tub to these terminals with an insulated or bare copper conductor not smaller than No. 6 AWG.

c) All field-installed metal components such as rails, ladders, drains or other similar hardware within 5 feet (1.5 m) of the hot tub shall be bonded to the equipment grounding buss with copper conductors not smaller than No. 6 AWG.

**WARNING:** To Reduce the Risk of Injury: The water in a hot tub should never exceed 104 °F (40 °C). Water temperatures between 100 °F (38 °C) and 104 °F (40 °C) are considered safe for a healthy adult. Lower water temperatures are recommended for young children and when hot tub use exceeds 10 minutes. Since excessive water temperatures have a high potential for causing fetal damage during the early months of pregnancy, pregnant or possibly pregnant women should limit hot tub water temperatures to 100 °F (38 °C). If pregnant, please consult your physician before using a hot tub. Before entering the hot tub, the user should measure the water temperature with an accurate thermometer since the tolerance of water temperature regulating devices may vary as much as +/- 5 °F (2 °C). Persons suffering from obesity or a medical history of heart disease, low or high blood pressure, circulatory system problems or diabetes should consult a physician before using a hot tub.

**CAUTION:** Risk of Hyperthermia: Hyperthermia occurs when the internal temperature of the body reaches a level several degrees above the

normal body temperature of 98.6 °F (37 °C). The symptoms of hyperthermia include drowsiness, lethargy, and an increase in the internal temperature of the body. Prolonged immersion in hot water may induce hyperthermia. A description of the causes, symptoms, and effects of hyperthermia are as follows:

- Unawareness of impending hazard;
- Failure to perceive heat;
- Failure to recognize the need to exit hot tub;
- Physical inability to exit hot tub;
- Fetal damage in pregnant women; and
- Unconsciousness and danger of drowning.

**WARNING:** Children should not use hot tubs without adult supervision.

**WARNING:** Do not use hot tubs unless all suction guards are installed to prevent body and hair entrapment.

**WARNING:** People with infectious diseases should not use a hot tub.

**WARNING:** To avoid injury, exercise care when entering or exiting the hot tub.

**WARNING:** Do not use drugs or alcohol before or during the use of a hot tub to avoid unconsciousness and possible drowning. The use of alcohol or drugs can greatly increase the risk of fatal hyperthermia in hot tubs.

**WARNING:** Pregnant or possibly pregnant women should consult a physician before using a hot tub.

**WARNING:** Water temperature in excess of 38 °C (100 °F) may be injurious to your health. Before entering the hot tub, measure the water temperature with an accurate thermometer.

**WARNING:** Do not use a hot tub immediately following strenuous exercise.

**WARNING:** Prolonged immersion in a hot tub may be injurious to your health.

**WARNING:** Do not permit electric appliances (such as lights, telephone, radio, television, etc.) within 5 feet (1.5m) of this hot tub unless such appliances are built-in by the manufacturer.

**WARNING:** People using medication and/or having an adverse medical history should consult a physician before using a spa or hot tub.

**CAUTION:** Observe a reasonable time limit when using the hot tub. Long exposures at higher temperatures can cause high body temperature. Symptoms may include dizziness, nausea, fainting, drowsiness, and reduced awareness. These effects could possibly result in drowning.

**CAUTION:** Enter and exit the hot tub slowly. Wet surfaces can be very slippery.

**CAUTION:** Proper chemical maintenance of hot tub water is necessary to maintain safe water and prevent possible damage to hot tub components. Maintain water chemistry in accordance with manufacturer's instructions.

**CAUTION:** Use the straps and clip tie downs to secure the cover when not in use. This will help to discourage unsupervised children from entering the hot tub and keep the hot tub cover secure in high-wind conditions. There is no representation that the cover, clip tie-downs, or actual locks will prevent access to the hot tub.

**CAUTION:** For exercise, the water should not exceed 90 °F (32 °C).

**CAUTION:** When using this electrical equipment, basic safety precautions should always be followed.

### PREPARATION AND SET-UP FOR YOUR NEW SPA LOCATION FOR YOUR NEW SPA:

- You want to keep in mind how you intend to use the spa and plan the location accordingly.
- How close is the spa from the exit or entrance to your house? (consider the cold weather)
- Is the path to your spa clean of debris, sand, grass? (so as not to track into the spa)
- Is there protection from wind, inclement weather?
- Can neighbors or passersby see the spa?

**NOTE: Allow for service access:** Many spa owners enjoy placing their spa in a decorative enclosure or a deck. Keep in mind that you need to have access to the equipment for maintenance and the spa should be able to be moved or lifted without destroying the special enclosure or its surroundings. You should discuss this with your dealer when designing the location. Extension cords are not to be used in conjunction with the operations of the spa. Low voltage damage could result and this is not covered by warranty. **NOTE:** All components must be 120V; No 240V components allowable.

**240VAC:** Depending on the model of spa, it will require either a 40 Amp, 50 Amp, or 60 Amp dedicated circuit breaker, GFCI, with the proper wire size based on the length of the run. The electrical circuit must be installed by a certified electrician and approved by a local building or electrical inspector.

### ELECTRICAL REQUIREMENTS

All self contained spas use 120VAC or 240VAC electrical spa packs.. These instructions describe the only acceptable electrical wiring procedures. Spas wired in any other way will void your warranty and may result in serious injury. All installations should be completed by a certified electrician. Failure to comply with state and local codes may result in fire or personal injury and will be the sole responsibility of the spa owner.

**120VAC:** This requires an isolated 15 Amp circuit breaker. This needs to be an isolated circuit with no other appliances or lights on this circuit at any time. Extension cords are not to be used in conjunction with the operations of the spa. Low voltage damage could result and this is not covered by warranty. **NOTE:** All components must be 120V; No 240V components allowable.

**240VAC:** Depending on the model of spa, it will require either a 40 Amp, 50 Amp, or 60 Amp dedicated circuit breaker, GFCI, with the proper wire size based on the length of the run. The electrical circuit must be installed by a certified electrician and approved by a local building or electrical inspector.

### SURFACE AND PAD REQUIREMENTS

Your new portable spa must be placed on a firm, flat and level surface, so the spa weight is supported uniformly. We recommend no less than a 3" (93 mm) thick concrete slab. Wood decking or balconies must be constructed to support 150 pounds per square foot (730 kg/m<sup>2</sup>). Refer to local and current building codes in your area. Consult an engineer for live loads in your area. Should your new spa need to go through a gate, the opening should be a minimum of 48 inches and up to 8.5' overhead clearance depending on the size of the unit.

**NOTE:** Damage caused by alternate decking methods may void the spa warranty. Contact your local dealer if you have any questions regarding spa location or placement.

### DRAINING AND WINTERIZING

#### DRAINING YOUR SPA

After a period of 3-4 months, detergent residues from bathing suits and soap film will build up in your spa water. Once this happens, your spa water will appear cloudy and should probably be replaced.

- Turn power OFF at the breaker.
- Locate the drain valve (usually in the equipment area).
- Remove the safety cap and attach garden hose.
- Drain water to a convenient area. (Spa water may harm grass or plants if sanitizer levels are high.)
- When water begins to flow out of the hose, open the air relief valve located on filter lid (Hydro-Cyclonic Filtration) or Air Bleeder Valve (Skim Filtration)
- Your spa will drain except for a small portion left in the foot well. This can be removed with a sponge and pail.
- Once empty, clean as required.
- To finish, remove garden hose and attach safety cap.



**IMPORTANT (Cascade Series Only):** There will be an additional drain valve. This is connected directly to the tank reservoir and you will see the water level go down on the sight tube in the equipment area.

#### WINTERIZING YOUR SPA

In many areas of the world the temperature may drop below 32°F (0°C). We recommend the spa is always filled with water and running at normal spa temperatures. By doing this you will minimize the risk of freezing within your spa. If it is necessary to leave your spa unattended for long periods of time during cold weather conditions, you should drain your spa to avoid accidental freezing caused by power outages. Your local dealer can perform the following winterizing procedures, if you are not completely comfortable with them.

- Ensure that you have fully drained the spa (Refer to the DRAINING YOUR SPA section)
- After draining, your spa may still have water remaining in the equipment and plumbing fittings. Disconnect the hand-tightened union fittings going to and from

the jet pumps. Be careful not to lose the o-rings between the unions and pump housing.

- Leave drain valve in the open position and safety cap off .
- To completely drain the plumbing lines, a wet/dry shop vacuum can be used to draw out any remaining water. Place the vacuum hose over the jet fittings in the spa as well as the plumbing lines in the equipment area. You should also disconnect the plug on the crystal clear inspection tube (if installed)
- Remove the filter cartridge and store in a warm, dry area.
- Clean the spa shell and place spa cover on spa. Be sure to lock the cover in place in case of high winds or rain.

**WARNING:** The instructions above should be followed accordingly when winterizing your spa however they are guidelines and potential freeze damage may still occur. All freeze damage is the sole responsibility of the spa owner and will not be covered by the warranty should it occur.

**EMERGENCY SITUATIONS:** To eliminate freezing in the event of equipment failure, use a 100-watt light bulb or small heater via extension cord and place it in the equipment area, keeping it away from plumbing lines. This will help for a short period of time until proper service can be rendered.



## DRAINING INSTRUCTIONS

1. On the control panel (settings) select **hold**. This will suspend all functions so that the spa can start to be drained.
2. Remove the false bottom in cabinet area.
3. Connect your hose to the hose bib located in the lower compartment. Open the hose bib valve until water starts coming out of the drain hose.
4. Turn evacuation pump power switch ON - located at the top left of the enclosure.
5. The length of time it will take to drain depends on the size of your spa. On average it will take approximately 1 hour.

**If you have an Infinity Edge Spa** allow it to drain for 30 minutes and then take it off of **hold**. Pump 1 will run on low speed to drain the tank into the main body of the spa.

Let pump 1 run on low speed until the water stops coming out of the jets/waterfall and immediately put the system back into **hold** (refer to step one).

6. Allow spa to finish draining. When fully drained, switch off the evacuation pump and close the hose bib valve.
7. Switch off power to the spa via the main GFCI Breaker.
8. You may have to use a shop vacuum to remove any excess water. Clean the spa before refilling. Refer to your Owner's Manual for proper filling instructions. Once the spa is filled, **prior to adding chemicals**, open the hose bib valve for approx. 15 seconds to allow fresh water to flush the Water-Vac™ System then close the hose bib valve.

### IMPORTANT PLEASE READ

Do not leave your spa unattended while draining. After 90 minutes the hold function is disabled and will allow your spa pumps to activate. This could cause damage to your equipment.

important to maintain a slightly alkaline condition of 7.2 to 7.8. Problems become proportionately severe the further outside of this range the water



### FILTER MAINTENANCE

The spa filter is one of the most important maintenance items of a hot tub. The filter is there to remove debris from the water and needs to be cleaned on a regular basis. Failure to do so may result in poor performance, poor water clarity and could prevent the spa from heating. Filtration starts as soon as flow is steady through the filter. As the filter cartridge removes the debris from the spa water, the accumulated debris causes flow resistance.

#### CLEANING AND REPLACING FILTER CARTRIDGE

Your spa filter has been designed for quick and easy maintenance. The filter cartridge should be rinsed by hose once a week and cleaned with a cartridge cleaner once a month. A second filter cartridge is recommended and will speed up this process. This can be purchased from your local dealer.

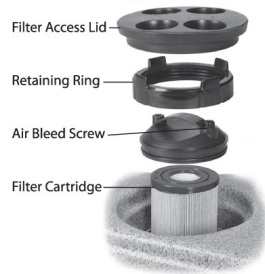

#### TOP LOAD FILTERS

- Turn power OFF at the breaker.
- Loosen air relief valve, then remove retainer ring.
- Pull filter lid straight up to remove.
- Do not twist or pull the filter lid up on an angle. This could cause damage to the filter canister, especially in freezing conditions.
- Remove filter cartridge and clean with a garden hose and a high-pressure nozzle. Periodically you may need to soak your filter in a "cartridge filter cleaner" to remove excess minerals and/or oils.
- Rinse filter thoroughly before installing. Clean o-ring on filter lid and apply a light film of silicone lubricant to the o-ring. Do not use a petroleum-based lubricant as it could damage the o-ring. Consult your dealer to purchase suitable lubricant.
- Place clean Cartridge in filter canister.
- Replace filter lid and re-tighten retaining ring (finger tight only)

**NOTE:** Make sure the o-ring is on the air relief valve, and is finger tight prior to starting the pump. This o-ring should periodically be lubricated with a silicone lubricant.

- There is a 3/8" clear line coming from the filter area and this goes to the bottom corner of the spa. This drains all the water from around the filter canister.
- This is a good time to check the skimmer basket. Bring skimmer door (weir) forward and unscrew basket. Clean out debris and reinstall.

Look for these specialized cleaning attachments at your local dealership.



### WATER QUALITY MAINTENANCE

Maintaining the quality of the water within the specified limits will serve to enhance your enjoyment and prolong the life of the hot tub's equipment. It is a fairly simple task, but it requires regular attention because the water chemistry involved is a balance of several factors. There is no simple formula, and there is no avoiding it. An indifferent approach to water maintenance will result in poor and potentially harmful conditions for soaking and even damage to your hot tub investment. The most important thing to keep in mind is that *preventing* poor water chemistry is much easier than *correcting* poor water chemistry. For specific guidance on maintaining water quality, consult your Authorized Dealer who can recommend appropriate chemical products for sanitizing and maintaining your hot tub.

#### MAINTAIN HEALTHY SPA WATER

**Important!** When maintaining your hot tub's water chemistry, ensure that your cover is removed during any aggressive treatments to allow for dissipation into the air. Take care to remove the cover slowly and let chemicals deplete if you are uncertain if your water is properly balanced. **Always maintain your hot tub's water chemistry within the following parameters:**

**pH:** pH is a measure of relative acidity or alkalinity of water and is measured on a scale of 0 to 14. The midpoint of 7 is said to be neutral, above which is alkaline and below which is acidic. In hot tub water, it is very

important to maintain a slightly alkaline condition of 7.2 to 7.8. Problems become proportionately severe the further outside of this range the water gets. A low pH will be corrosive to metals in the hot tub equipment. A high pH will cause minerals to deposit on the interior surface (scaling). In addition, the ability of the sanitation agents to keep the hot tub clean is severely affected as the pH moves beyond the ideal range. That is why almost all hot tub water test kits contain a measure for pH as well as sanitizer.

**Sanitizer (Chlorine or Bromine):** To destroy bacteria and organic compounds in the hot tub water by breaking them down into non-harmful levels which get filtered out. A sanitizer must be used regularly, either chlorine or bromine. Sanitizing your spa water is the most important spa maintenance you can do for yourself.

**Total Alkalinity:** This refers to the ability of the hot tub water to resist changes in pH. Controlling alkalinity can help keep your pH in the appropriate range thereby lessening the need for pH balancing. If the TA is too low the pH level will fluctuate rapidly from high to low. If the TA is too high the pH will tend to be too high and will be very difficult to bring back down.

**Calcium Hardness:** This is a measurement of dissolved calcium in the water. Calcium will help control the corrosive nature of the spa's water.

**WARNING:** Never store chemicals inside the equipment area of your spa.

**IMPORTANT:** Do not use Hydrogen Peroxide based sanitizers in your spa. When using Chlorine or Bromine tablets you must use a floating dispenser. These chemicals can have an extremely corrosive effect on certain materials in the spa. Damage caused by use of these chemicals, or improper use of any chemicals, is not covered under the spa's warranty.

**OTHER ADDITIVES:** Many other additives are available for your spa. Some are necessary to compensate for out-of-balance water, some aid in cosmetic water treatment and others simply alter the feel or smell of the water. Your Authorized Dealer can advise you on the use of these additives.

**WATER CLARITY TROUBLESHOOTING**

PROBLEM	PROBABLE CAUSE	POTENTIAL SOLUTIONS
<b>Water Odor</b>	<ul style="list-style-type: none"> <li>• Improper sanitization</li> <li>• Excessive organics in water</li> <li>• pH is too low</li> </ul>	<ul style="list-style-type: none"> <li>&gt; Add sanitizer</li> <li>&gt; Shock spa with sanitizer</li> <li>&gt; Adjust pH</li> </ul>
<b>Chlorine Odor</b>	<ul style="list-style-type: none"> <li>• Chloramines are too high</li> <li>• pH is too low</li> </ul>	<ul style="list-style-type: none"> <li>&gt; Shock spa with sanitizer</li> <li>&gt; Adjust pH</li> </ul>
<b>Musty Odor</b>	<ul style="list-style-type: none"> <li>• Bacteria or Algae growth</li> </ul>	<ul style="list-style-type: none"> <li>&gt; Shock spa with sanitizer</li> <li>&gt; Drain and refill spa water</li> </ul>
<b>Scale</b>	<ul style="list-style-type: none"> <li>• Total alkalinity is too high</li> <li>• pH is too high</li> <li>• High calcium content in water</li> </ul>	<ul style="list-style-type: none"> <li>&gt; Adjust total alkalinity</li> <li>&gt; Adjust pH</li> <li>&gt; Use stain and scale product</li> </ul>
<b>Stains</b>	<ul style="list-style-type: none"> <li>• Total alkalinity is too low</li> <li>• pH is too low</li> <li>• High metal content in water</li> </ul>	<ul style="list-style-type: none"> <li>&gt; Adjust alkalinity</li> <li>&gt; Adjust pH</li> <li>&gt; Use stain and scale product</li> </ul>
<b>Cloudy Water</b>	<ul style="list-style-type: none"> <li>• Poor filtration</li> <li>• pH is too high</li> <li>• Hardness is too high</li> <li>• Total alkalinity is too high</li> <li>• Suspended particles</li> </ul>	<ul style="list-style-type: none"> <li>&gt; Clean filter cartridge</li> <li>&gt; Adjust pH</li> <li>&gt; Adjust hardness</li> <li>&gt; Adjust total alkalinity</li> <li>&gt; Drain and refill spa water</li> </ul>
<b>Algae Growth</b>	<ul style="list-style-type: none"> <li>• pH is too high</li> <li>• Sanitizer is too low</li> </ul>	<ul style="list-style-type: none"> <li>&gt; Adjust pH</li> <li>&gt; Shock spa with sanitizer</li> <li>&gt; Adjust sanitizer level</li> </ul>
<b>Eye Irritation</b>	<ul style="list-style-type: none"> <li>• pH is too low</li> <li>• Sanitizer is too low</li> </ul>	<ul style="list-style-type: none"> <li>&gt; Adjust pH</li> <li>&gt; Shock spa with sanitizer</li> <li>&gt; Adjust sanitizer level</li> </ul>
<b>Skin Rash/Irritation</b>	<ul style="list-style-type: none"> <li>• Free chlorine level too high</li> <li>• Unsanitary water</li> </ul>	<ul style="list-style-type: none"> <li>&gt; Adjust chlorine level</li> <li>&gt; Shock spa with sanitizer</li> <li>&gt; Adjust sanitizer level</li> </ul>

### PRODUCT & CARE GUIDE

Your Authorized Dealer carries a wide variety of care and maintenance products. For more information please contact your Dealer.

#### REQUIRED FILTER MAINTENANCE

Your new hot tub is equipped with a filter cartridge. To ensure maximum water quality at all times, you should replace the filter cartridge every six months, or earlier as necessary. The filter cartridge is designed to be thrown away! Attempts to re-use the filter cartridge may result in the re-release of unwanted particles back into the hot tub.

#### PLEATCO DUAL CORE FILTERS

Your hot tub/spa comes with a premium filter. Most come with equipped with a Pleatco DualCore Filter, which does a better job of cleaning your spa water than any other filter cartridge. The DualCore filter has two layers of filtration media, the outer layer and the inner layer. Both are engineered to remove different particles from your water.



The outer core is similar to a traditional filter which traps larger debris, while the inner core filters the water for particles down to 3 microns in size. The inner core is easily removed and both filter media can be cleaned.

Keeping your spa water clean and refreshing is extremely important for your enjoyment of your hot tub. Our hot tubs come with only the best filters available in order to ensure your satisfaction.

#### REQUIRED WATER REPLACEMENT

You should replace the hot tub's water every 3-6 months. The frequency will depend on a number of variables including frequency of use, number of bathers and attention paid to the water quality maintenance. You will know it is time for a change when you can no longer get the normal feel or sparkle to the water, even though the key water balance measurements are all within the recommended ranges.

#### HEADREST / PILLOW CARE

The pillows can be removed for easy cleaning and maintenance. All pillows have plugs within the pillow itself. To remove the pillow, grab the bottom edge firmly and pull outward. This will allow the pillows to pop-out from the receptacle in the spa shell. To reinstall the pillow you will align the pillow plug with the receptacle. Press/hit the front side of the pillow firmly, which will insert the plug back into the receptacle.

- **Proper water chemistry must be maintained. Your hot tub pillows are easily and quickly damaged when exposed to unbalanced spa water.** If you suspect that your chemicals may be unbalanced, remove your pillows immediately until the water has been restored to suggested conditions.
- Do not sit on the pillows

- Do not pull on the pillows
- Pillows should be cleaned using a soft cloth and mild soap, then wiped with a conditioner. We recommend that pillows be washed each time you drain your spa.

This Limited Warranty is void if failure is caused by accident, acts of nature, acts of God, or other causes beyond the control of CSML. Neglect, misuse and abuse include any installation, operation, or maintenance of the spa other than in accordance with the instructions contained in the owner's manual provided with the spa, including, but not limited to damage caused by operation outside the range of 34 degrees Fahrenheit and 116 degrees Fahrenheit or 1 degree Celsius and 47 degrees Celsius .

Please be advised that the Spa Warranty will become void if Coast Spas or any of its selling or servicing agents determines that the spa has been exposed to Hydrogen Peroxide, TriChlor or any substance using it as an ingredient proven to be dangerous to the Spa. Any condition arising from the use of Hydrogen Peroxide or TriChlor on the Spa is not a warrantable defect.

#### HOT TUB INTERIOR

Your hot tub has a fiberglass reinforced acrylic shell. Generally dirt and stains will not adhere to the surface. To properly clean the surface, we recommend wiping it with a soft damp cloth (or sponge) using a low-sudsing household soap or liquid detergent and rinsing thoroughly with fresh water. Stubborn dirt or stains may be removed by using Spic & Span adequately dissolved in water. Contact your dealer and inquire about maintenance packages.

**DO NOT** use any cleaning products containing abrasives or solvents, since these could damage the surface. Harsh chemicals should never be used on acrylic surfaces. Damage to the shell due to the use of harsh chemicals is not covered under the warranty.

**DO NOT** leave your hot tub drained and in direct sunlight for extended periods of time. Extreme heat could cause damage to the acrylic surface and may induce an effect known as "crazing".

#### STAINLESS STEEL CONTROLS AND COMPONENTS ABOVE THE WATER LINE

To preserve the stainless steel finish of the controls and components above the water line, we recommend they be wiped with a dry soft cloth after each use of your hot tub. In addition, off-gas your tub by removing the cover for approximately 30 minutes multiple times per week (if not in use) and after every shock treatment.

#### CABINET CARE

Never spray cabinets with a high-pressure garden hose or pressure washer for any reason. This action may induce an electrical short in the hot tub's electrical equipment.

#### CEDAR CABINET

Our cedar cabinets are made from top quality Western Cedar and manufactured and stained at our factory. With proper care and maintenance, your cedar cabinet should maintain its beauty for many years. Manufacturer recommends touch-up or re-staining of the cabinet every three to four years depending on your environment. Contact your Dealer for re-staining procedures.

### VINYL CABINET

Vinyl cabinets are made of a rigid polymer that combines the durability of plastic with the beauty of real wood. This cabinet is manufactured so that it won't crack, peel, blister or delaminate even after prolonged exposure to the elements. We recommend wiping the cabinet with a soft damp cloth (or sponge) using household soap or liquid detergent and rinsing with fresh water thoroughly. **DO NOT** use abrasive cleansers or material as this may damage the surface.

### SLATE CABINETS

Optional Slate cabinets are custom-built and painted in our factory. We recommend lightly brushing the cabinet with a SOFT bristle brush to remove any dirt or stains. For more information on the care of your Slate cabinet, please contact your Local Dealer.

### COVER CARE

A well cared for spa cover is a thing of beauty in its own right. Be sure to clean and condition your cover at least once a month – more often if needed. Your cover needs to be cleaned and conditioned because vinyl can be dry and become brittle, spoiling your spa's appearance. Dry, brittle vinyl can also tear at the seams and stress points. Quality materials, internal sewn reinforcing and careful workmanship can only go so far against the ravages of Mother Nature. See the specific Warranty card enclosed with your cover for further details.

- When you shock your spa you need to remove the cover for a minimum of 30 minutes to ensure that the chemical gas off can escape from the spa.
- You are required to keep the spa covered at all time when not in use to protect the shell from harmful UV rays.
- A covered spa will use less electricity when maintaining the desired water temperature
- See the manual that comes with the cover for proper mounting of the cover locks
- The cover should remain locked at all times to prevent unauthorized entry into the spa and potential drowning.
- Do not Sit, Stand or Lie on your cover. Nor should you place any heavy object on top of the cover as this may damage the structure.

**VERY IMPORTANT:** We recommend a vinyl conditioner for your spa cover. Your local dealer carries a wide variety of care and maintenance products. Choose a pleasant day each month to remove your cover from the spa and lay it on a flat surface accessible by garden hose. Douse the cover with a healthy amount of water from the hose or a bucket to rinse away loose dirt or debris. Using a soft bristle brush and a mild solution of dishwashing liquid (about one teaspoon of detergent to two gallons of water), and with a gentle circular motion, scrub the cover clean. Be careful not to let any areas of the cover dry before they're thoroughly rinsed. Now apply the vinyl conditioner as directed on the container. Massage the conditioner into the cover in a gentle but firm manner. Before replacing the cover on your spa, wipe and rinse any dirt

from the bottom of the cover. When you are ready, put the cover on the spa.

**NOTE:** To remove tree sap, use lighter fluid (not charcoal lighter but the fluid used in cigarette lighters). Use sparingly, then immediately apply conditioner to that area.

All waterfalls and laminar flow water features should be turned off when the spa is not in use to avoid heat and water loss



### GLOSSARY OF TERMS

**AIR CONTROL VALVE:** Mounted generally on the lip of the spa, it induces warm air from the equipment enclosure into the jet stream through venturi action.

**WATER DIVERTER VALVE:** The large diverter is used to divert water to various seats in the spa.

**ON/OFF DIVERTER VALVE:** The smaller diverter is used to control water flow and to turn on/off the neck jets and/or waterfalls.

**FILTER AIR RELIEF VALVE:** Located on top of dome filter lid. Used to release air from the filter.

**SKIMMER BLEEDER VALVE:** Located in the skimmer area, needs to be loosened while filling the spa. This will help eliminate air from being trapped in the spa equipment.

**OZONATOR:** Available as an option. The ozonator produces natural ozone through the Corona Discharge process. Continuous use of an ozonator can dramatically reduce sanitizer consumption.

**CONTROL BOX (Pack):** Basically the "heart" of the spa. Power is distributed to any/all functions of the spa: pumps, ozonator, LED lighting, heater element, etc.

**CONTROL PANEL:** Mounted on the top lip of the spa and controls the functions of the spa.

**DRAIN VALVE:** Used in draining of the spa. Normally located in the equipment area.

**EQUIPMENT ENCLOSURE:** An enclosure that houses the control box, pump(s) and other electrical components.

**FILTER:** The filter cleans the spa by passing water through a filter cartridge where debris and impurities are removed. Top load filter means the filter cartridge is accessible through the top of the spa. Front access skimmer means cartridge is accessed through door of skimmer.

**FLOOR DRAIN:** The floor drain is covered by a grate-type cover and is utilized when draining the spa. It also acts as the return for the ozonator. You will see bubbles emitted from this drain, which is the result of water mixing with the ozone output.

**GATE VALVES:** Red with a grey handle is located at the inlet and outlet of the pumping system. Used while servicing the spa equipment, the valves open or close the water flow to the equipment. To remain open for normal use, turn fully counterclockwise.

**KNIFE VALVES:** A white "T"-handled valve, same functions as Gate valve (see above), except to open them you pull up on handle.

**HEATER:** The electronically controlled heater raises the temperature of the spa to the desired setting.

**LEDs:** LEDs and their special lenses can be used to achieve the desired mood lighting in the spa and spa jets.

**SKIMMER:** This is the rectangular outlet at the water level. The skimmer removes surface debris to the filter. The water level in the spa should be kept  $\frac{1}{2}$  to  $\frac{3}{4}$  up on the skimmer for optimum operation.

**SUCTION FITTING:** During operation of the equipment, the suction works in conjunction with the skimmer to draw water from the bottom of the spa through the filter, keeping the spa sparkling clean.

**NECK JET:** Direction-controllable jet for soothing neck massage.

**ADJUSTABLE CLUSTER JET:** Our adjustable, high-intensity hydrotherapy jet.

**DIRECTIONAL JET:** Provides a straight flow for a therapeutic massage

**ROTATIONAL JET:** Provides a Uni-directional circular therapeutic massage.

**MESSAGE JET:** Delivers massage in staccato bursts over a narrow, focused area.

**VOLCANO/WHIRLPOOL JET:** high-output jet designed for foot and leg massage.

**LAMINAR FLOW WATER FEATURE:** A thin stream of water that arcs from the spa lip.

## **BASIC INSTALLATION AND CONFIGURATION GUIDELINES**

### **Warning! Qualified Technician Required for Service and Installation**

Use minimum 6AWG copper conductors only. Torque field connections between 21 and 23 in lbs. Readily accessible disconnecting means to be provided at time of installation. Permanently connected power supply. Connect only to a circuit protected by a Class A Ground Fault Circuit Interrupter (GFCI) or Residual Current Device (RCD) mounted at least 5' (1.52M) from the inside walls of the spa/hot tub and in line of sight from the equipment compartment.

### **CSA ENCLOSURE: TYPE 2**

Refer to Wiring Diagram inside the cover of the control enclosure. Refer to Installation and Safety Instructions provided by the spa manufacturer.

**Warning:** People with infectious diseases should not use a spa or hot tub.

**Warning:** To avoid injury, exercise care when entering or exiting the spa or hot tub.

**Warning:** Do not use a spa or hot tub immediately following strenuous exercise.

**Warning:** Prolonged immersion in a spa or hot tub may be injurious to your health.

**Warning:** Maintain water chemistry in accordance with the Manufacturers instructions.

**Warning:** The equipment and controls shall be located no less than 1.5 meters horizontally from the spa or hot tub.

### **WARNING! GFCI OR RCD PROTECTION.**

The Owner should test and reset the GFCI or RCD on a regular basis to verify its function.

### **WARNING! SHOCK HAZARD! NO USER SERVICEABLE PARTS.**

Do not attempt service of this control system. Contact your dealer or service organization for assistance. Follow all owner's manual power connection instructions. Installation must be performed by a licensed electrician and all grounding connections must be properly installed.

- Disconnect the electric power before servicing. Keep access door closed.

### **CSA COMPLIANCE**

#### **Caution:**

- Test the ground fault circuit interrupter before each use of the spa.
- Read the instruction manual.
- Adequate drainage must be provided if the equipment is to be installed in a pit.
- For use only within an enclosure rated CSA Enclosure 3.
- Connect only to a circuit protected by a Class A ground fault circuit interrupter or residual current device.
- To ensure continued protection against shock hazard, use only identical replacement parts when servicing.
- Install a suitably rated suction guard to match the maximum flow rate marked.

#### **Warning:**

- Water temperature in excess of 38°C may be injurious to your health.
- Disconnect the electrical power before servicing.

**TROUBLESHOOTING GUIDE**

**SPA SYSTEM**

SYMPTOM	PROBABLE CAUSE	RECOMMENDED ACTION
<b>Spa does not work</b>	<ul style="list-style-type: none"> <li>• Power is turned off</li> </ul>	<ul style="list-style-type: none"> <li>&gt; Reset GFCI</li> </ul>
<b>No display on the control panel</b>	<ul style="list-style-type: none"> <li>• Power is turned off</li> <li>• Defective topside control</li> </ul>	<ul style="list-style-type: none"> <li>&gt; Reset GFCI</li> <li>&gt; Contact your Dealer</li> </ul>
<b>Letters on the control panel</b>	<ul style="list-style-type: none"> <li>• An error has been found</li> </ul>	<ul style="list-style-type: none"> <li>&gt; Refer to the Reference Card for your control panel to verify the error. Contact your Dealer for service</li> </ul>

**PUMP PROBLEMS**

SYMPTOM	PROBABLE CAUSE	RECOMMENDED ACTION
<b>Noisy/Loud motor</b>	<ul style="list-style-type: none"> <li>• Air trapped in the pump</li> <li>• Low water level</li> <li>• Worn pump seal</li> <li>• Defective pump</li> </ul>	<ul style="list-style-type: none"> <li>&gt; Open bleed valve in the skimmer</li> <li>&gt; Add water to the spa</li> <li>&gt; Contact your Dealer</li> <li>&gt; Contact your Dealer</li> </ul>
<b>Pumps power down on their own</b>	<ul style="list-style-type: none"> <li>• Set temperature has been reached</li> <li>• Filtration cycle has ended</li> <li>• Automatic time out</li> <li>• Overheat safety protection</li> </ul>	<ul style="list-style-type: none"> <li>&gt; No problem</li> <li>&gt; No problem</li> <li>&gt; Pumps are set to run for a predetermined time while the spa is in use (15-20 Mins)</li> <li>&gt; The pumps have a thermal overload which will prevent them from running for extended periods of time. Wait until pumps have cooled down (1+ hrs). If problem persists, contact your Dealer.</li> </ul>
<b>Pump running constantly, will not turn off</b>	<ul style="list-style-type: none"> <li>• Filter cycle set to 24 hours</li> <li>• Problem with the circuit board</li> </ul>	<ul style="list-style-type: none"> <li>&gt; Turn off 24 hour filtration</li> <li>&gt; Turn power off at GFCI and contact your Dealer</li> </ul>
<b>Pump will not turn on</b>	<ul style="list-style-type: none"> <li>• GFCI tripped</li> <li>• Motor has overheated</li> <li>• Not plugged in</li> <li>• Damaged plug</li> <li>• Seized motor</li> <li>• Blown fuse</li> <li>• Motor vent is blocked</li> </ul>	<ul style="list-style-type: none"> <li>&gt; Reset the GFCI</li> <li>&gt; Let cool for 1+ hour</li> <li>&gt; Plug in to the board</li> <li>&gt; Contact your Dealer</li> <li>&gt; Contact your Dealer</li> <li>&gt; Check fuse or contact your Dealer</li> <li>&gt; Clear debris from the vent</li> </ul>

<b>HEAT PROBLEMS</b>	<b>PROBABLE CAUSE</b>	<b>RECOMMENDED ACTION</b>
<b>Water will not heat</b>	<ul style="list-style-type: none"> <li>• Error message on control panel</li> <li>• Spa is in a different Heat Mode</li> <li>• Water level is too low</li> <li>• Poor water flow</li> <li>• Closed valves</li> <li>• Pump 1 is not running</li> </ul>	<ul style="list-style-type: none"> <li>&gt; Refer to the Reference Card for your control panel to verify the error</li> <li>&gt; Set spa to "Standard Mode"</li> <li>&gt; Add water to the spa</li> <li>&gt; Clean filter &amp; check valves</li> <li>&gt; Open all valves</li> <li>&gt; Contact your dealer</li> </ul>
<b>Water is too hot</b>	<ul style="list-style-type: none"> <li>• Incorrect reading</li> <li>• Filter cycle duration is too long</li> <li>• Pump speeds reversed</li> </ul>	<ul style="list-style-type: none"> <li>&gt; Verify temperature with thermometer</li> <li>&gt; Reduce duration of the filter cycle</li> <li>&gt; Contact your dealer</li> </ul>
<b>Water will not maintain heat</b>	<ul style="list-style-type: none"> <li>• Cover is off for extended periods of time in cold weather / cold wind.</li> <li>• Hot tub is wired for 110V and jets are on.</li> </ul>	<ul style="list-style-type: none"> <li>&gt; Put cover back onto hot tub and allow for heat to regenerate. Call your dealer if temperature does not increase.</li> <li>&gt; Hot tubs wired for 110V only have enough power to heat or operate pumps. Turn off jets to power heater.</li> </ul>

<b>LIGHTING ISSUES</b>	<b>PROBABLE CAUSE</b>	<b>RECOMMENDED ACTION</b>
<b>Standard light will not come on</b>	<ul style="list-style-type: none"> <li>• Bulb has burnt out</li> </ul>	<ul style="list-style-type: none"> <li>&gt; Replace the light bulb</li> </ul>
<b>LED lighting not in sync</b>	<ul style="list-style-type: none"> <li>• Burnt out bulb/connection</li> </ul>	<ul style="list-style-type: none"> <li>&gt; Contact your dealer</li> </ul>
<b>LED lighting won't come on</b>	<ul style="list-style-type: none"> <li>• Incorrect settings</li> </ul>	<ul style="list-style-type: none"> <li>&gt; Contact your dealer</li> </ul>





<b>PUMPS WILL NOT PRIME</b>	<b>PROBABLE CAUSE</b>	<b>RECOMMENDED ACTION</b>
<b>Pump on but no water flow</b>	<ul style="list-style-type: none"> <li>• Air trapped in pump</li> <li>• No water in the pump</li> <li>• Closed valves</li> </ul>	<ul style="list-style-type: none"> <li>&gt; Loosen bleed valve in skimmer</li> <li>&gt; Check the fill level in the spa</li> <li>&gt; Open all valves</li> </ul>

<b>HYDROTHERAPY JETS</b>	<b>PROBABLE CAUSE</b>	<b>RECOMMENDED ACTION</b>
<b>Little to no water flowing from jets</b>	<ul style="list-style-type: none"> <li>• Jets turned off</li> <li>• Pump not primed</li> <li>• Valves are closed</li> <li>• Diverter set to a different seat</li> <li>• Dirty filter</li> </ul>	<ul style="list-style-type: none"> <li>&gt; Open jet by turning the face counter clockwise</li> <li>&gt; Reset breaker to allow for the spa to prime the pump. Open bleed valve in the skimmer area</li> <li>&gt; Open valves</li> <li>&gt; Switch diverter</li> <li>&gt; Remove and clean filter cartridge</li> </ul>

<b>PLUMBING SYSTEM</b>	<b>PROBABLE CAUSE</b>	<b>RECOMMENDED ACTION</b>
<b>Water around base of spa</b>	<ul style="list-style-type: none"> <li>• Loose connections</li> <li>• Leak from internal fitting</li> </ul>	<ul style="list-style-type: none"> <li>&gt; Hand tighten all quick disconnects and fittings.</li> <li>&gt; Check gaskets and o-rings</li> <li>&gt; Contact your dealer</li> </ul>





-  UP
-  DOWN
-  MENU
-  LIGHT
-  JET 1
-  JET 2/Return
-  Swim 1
-  Swim 2
-  Swim 3

**Introduction**

**PRIMING MODE**

When power is ON, the system will enter a priming mode with priming screen display on the panel. In this mode, all devices such as JETS and LIGHT are operable. JETS can be turned on and off to prime the pump. System will exit priming mode and go to MAIN display when RETURN button is pushed, or after 4 minutes of inactivity.

**SPA OPERATION**

Turn system accessories ON and OFF by pushing appropriate button on the right side of panel (LIGHT, JET 1...) These accessories have timeout defaults from the manufacturer and will turn OFF automatically after the time has expired. Timeout time for LIGHT default is 60 minutes; JET at low speed default is 60 minutes; and JET at high speed is 15 minutes. User can change these default times in "DEVICE TIMEOUT" setting menu.

**MENU NAVIGATING**

- MENU button: use to enter setting menu and sub-menu screens. For screens with several settable fields (example: DATE-TIME screen), use MENU button to navigate between different fields within the screen.
- UP and DOWN button: use to navigate between different options or changing values of a field.
- RETURN button: use to confirm the setting and goes back to previous screen.

SETTING TEMPERATURE: To change water set temperature, use UP and DOWN buttons to set the desired temperature. The screen will display "SET TEMP" with the current set temperature. After 5 seconds without any change to the set temperature, the screen will reverse back to MAIN screen with current water temperature display. Changing set temperature will make heat pump turn on to get accurate water temperature to determine if water needs to be heated up.

**PANEL TIMEOUT**

If user is in Setting Menus and no button is pushed within 15 seconds, the screen will timeout, current screen setting will be lost and panel reverts back to MAIN screen.

In MAIN screen, if no button is pushed within 60 minutes, all LED and LCD lights will turn off and panel goes to sleep. Any button pushed in this time will wake the panel up, LED and LCD lights will turn back on and panel will poll for water temperature.

**SETTING TEMPERATURE**

To change water set temperature, use UP and DOWN buttons to set the desired temperature. The screen will display "SET TEMP" with the current set temperature. After 5 seconds without any change to the set temperature, the screen will reverse back to MAIN screen with current water temperature display. Changing set temperature will make heat pump turn on to get accurate water temperature to determine if water needs to be heated up.

ERROR SCREENS

**Plumbing Error**



Press RETURN to clear

Error caused when SENSOR 1 and SENSOR 3 have been plugged in incorrectly. Swap the SENSOR 1 and SENSOR 3 plug in controller to correct this problem.

**Insufficient Flow**



Press RETURN to clear

Error caused by no water flow through heater or no water in heater. Check to be sure there is enough water flow through heater.

**Low Flow**



Press RETURN to clear

Check to be sure there is enough water flow through heater.

**Water Overheat**



Press RETURN to clear

Wait for water temperature to cool down. Check to be sure there is enough water flow through heater.

**Heater Overheat**



Press RETURN to clear

Wait for water temperature to cool down. Check to be sure there is enough water flow through heater.

**Potential Freeze**



Press RETURN to clear

Error caused when SENSOR 1, 2, or 3 detects low temperature. All JETS and BLOWERS will turn on automatically to protect plumbing from freezing. JETS and BLOWERS will shut down when all 3 SENSORS reach a desired temperature.



**PRIMING MODE**

When power is ON, the system will enter a priming mode with priming screen display on the panel. In this mode, all devices such as JETS and LIGHT are operable. JETS can be turned on and off to prime the pump. System will exit priming mode and go to MAIN display when RETURN button is pushed, or after 4 minutes of inactivity.

**SPA OPERATION**

Turn system accessories ON and OFF by pushing appropriate button on the right side of panel (LIGHT, JET 1...) These accessories have timeout defaults from the manufacturer and will turn OFF automatically after the time has expired. Timeout time for LIGHT default is 60 minutes; JET at low speed default is 60 minutes; and JET at high speed is 15 minutes. User can change these default times in "DEVICE TIMEOUT" setting menu.

**MENU NAVIGATING**

- MENU button: use to enter setting menu and sub-menu screens. For screens with several settable fields (example: DATE-TIME screen), use MENU button to navigate between different fields within the screen.
- UP and DOWN button: use to navigate between different options or changing values of a field.
- RETURN button: use to confirm the setting and goes back to previous screen.

SETTING TEMPERATURE: To change water set temperature, use UP and DOWN buttons to set the desired temperature. The screen will display "SET TEMP" with the current set temperature. After 5 seconds without any change to the set temperature, the screen will reverse back to MAIN screen with current water temperature display. Changing set temperature will make heat pump turn on to get accurate water temperature to determine if water needs to be heated up.

**PANEL TIMEOUT**

If user is in Setting Menus and no button is pushed within 15 seconds, the screen will timeout, current screen setting will be lost and panel reverts back to MAIN screen.

In MAIN screen, if no button is pushed within 60 minutes, all LED and LCD lights will turn off and panel goes to sleep. Any button pushed in this time will wake the panel up, LED and LCD lights will turn back on and panel will poll for water temperature.

**SETTING TEMPERATURE**

To change water set temperature, use UP and DOWN buttons to set the desired temperature. The screen will display "SET TEMP" with the current set temperature. After 5 seconds without any change to the set temperature, the screen will reverse back to MAIN screen with current water temperature display. Changing set temperature will make heat pump turn on to get accurate water temperature to determine if water needs to be heated up.







**SWIM SPA & SWIM WORKOUT**

1. Press the SWIM button to turn the pump ON – the blue SWIM icon on the LCD screen turns ON.
2. Then press UP or DOWN button to select your desired SPEED #.
3. Press the SWIM button again to turn OFF the pump the blue SWIM icon on the LCD screen turns OFF.

**SWIM WORKOUT PROGRAMMING**

1. To program the SWIM WORKOUT; press the MENU button; then UP button and select SWIM **WORKOUT** by pressing the **MENU** button to get to the **WARM UP** setting.
2. Press the **UP** or **DOWN** button to select the **SPEED #** for **WARM UP**; then press the **MENU** button to select **DURATION** in minutes; then press the **MENU** button twice to get to **WORKOUT**.
3. Press the **UP** or **DOWN** button to select the **SPEED #** for **WORKOUT**; then press the **MENU** button to select **DURATION** in minutes; then press the **MENU** button twice to get to **COOL DOWN**.
4. Press the **UP** or **DOWN** button to select the **SPEED #** for **COOL DOWN**; then press the **MENU** button to select **DURATION** in minutes; then press the **RETURN** button twice to get out of **SWIM WORKOUT**.
5. Press the **SWIM WORKOUT** button to turn **ON** the pump – the red **SWIM** icon on the **LCD** screen turns **ON**. The **WORKOUT** feature will activate to cycle each of the **SPEED** setting and specific **DURATION** setting for **WORKOUT**. If you need to increase or decrease the pump speed manually; then press the **UP** or **DOWN** button to your desired **SPEED #** in each cycle.
6. Press the **SWIM WORKOUT** button again to turn **OFF** the pump – the red **SWIM** icon on the **LCD** screen turns **OFF**.

**ERROR SCREENS**

<b>Plumbing Error</b>	 <p>Press RETURN to clear</p>	Error caused when SENSOR 1 and SENSOR 3 have been plugged in incorrectly. Swap the SENSOR 1 and SENSOR 3 plug in controller to correct this problem.
<b>Insufficient Flow</b>	 <p>Press RETURN to clear</p>	Error caused by no water flow through heater or no water in heater. Check to be sure there is enough water flow through heater.
<b>Low Flow</b>	 <p>Press RETURN to clear</p>	Check to be sure there is enough water flow through heater.
<b>Water Overheat</b>	 <p>Press RETURN to clear</p>	Wait for water temperature to cool down. Check to be sure there is enough water flow through heater.
<b>Heater Overheat</b>	 <p>Press RETURN to clear</p>	Wait for water temperature to cool down. Check to be sure there is enough water flow through heater.
<b>Potential Freeze</b>	 <p>Press RETURN to clear</p>	Error caused when SENSOR 1, 2, or 3 detects low temperature. All JETS and BLOWERS will turn on automatically to protect plumbing from freezing. JETS and BLOWERS will shut down when all 3 SENSORS reach a desired temperature.

**PRV 19 STEREO SYSTEM**

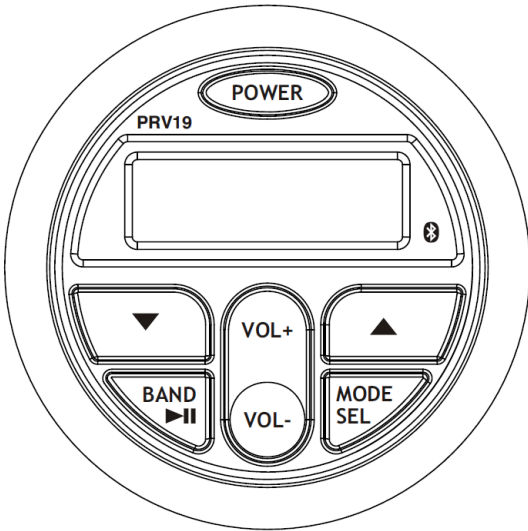

**FRONT PANEL LAYOUT**

- Power** Power On/Off  
Short push for the first time to turn unit on.  
With unit powered on, short push for MUTE feature.  
Press and hold for more than 2 seconds to turn the unit off.
- MODE** Mode Function.
- SEL** Switches amongst Radio, USB, and Auxiliary.  
SEL stands for SELECT.
- BAND** In Radio mode, this works Band Function.  
▶|| In MP3 playing mode, it works Play/Pause function
- VOL +** Volume Increase
- VOL -** Volume Decrease
- ▼ Track Down/Tune Down/Reverse
- ▲ Track Up/Tune Up/Fast Forward

**GENERAL OPERATION**

- **SEL button** Press and hold this button to enter into SELECT function, then repeatedly short push in succession results in the following menu options: Bass, Treble, Balance, Fader, Loud, EQ, Beep, Initial Volume, Area. Press VOL + or VOL - to adjust the options.
- **LOUD.** Choose between Loud ON or OFF
- **EQ.** Choose between Classic, Pop, Rock, Jazz and EQ off.
- **Beep.** Choose between Beep ON, Beep 2ND, Beep OFF.
- **Initial Volume.** Refers to the loudness level upon start of the receiver.
- **Area.** Choose between USA and European.

**RADIO OPERATION**

- A. **Press ▶||** button (BAND function) to access FM and AM. There are three FM bands and two AM bands.
- B. **Tuning.** A short press of the ▼ or ▲ button results in a search of the station and stops at next sufficient signal strength. A long press results in manual tuning mode.

**USB OPERATION**

- A. Insert a USB stick into the USB slot. \* Songs must be of the mp3 or wma format. \*
- B. ▶|| button. Press it to pause the track. Press it again to resume play.
- C. ▼ and ▲ button (Track Up / Track Down)  
Short press Track Up or Track Down button to select the next or previous track. Press and hold Track Up or Track Down button to go fast forward and rewind the current

**BLUETOOTH OPERATION**

The Media device must Bluetooth capability in order to stream music.

- A. To pair your Bluetooth device, press the MODE button on the stereo until BT AUDIO appears.
- B. Press and hold the BAND button until PAIRING appears.
- C. Next, go to settings on the Bluetooth device and turn the Bluetooth option to "on".
- D. Select the "PRV19" from available devices. If you are prompted for a passcode enter "1234". If the stereo does not immediately pair press the BAND button. This will allow the pairing process to finalize. A noise will alert you that the devices are paired.  
The display will also read "CONN OK" (Connection Okay).

Note: To disconnect your device press and hold the BAND button. The display will read "DISCONN" to alert you the disconnection is complete.

Note: While playing BT Music press the ▶|| to pause or resume playback.

**AQ-DM-6UBT—DIGITAL MEDIA LOCKER**

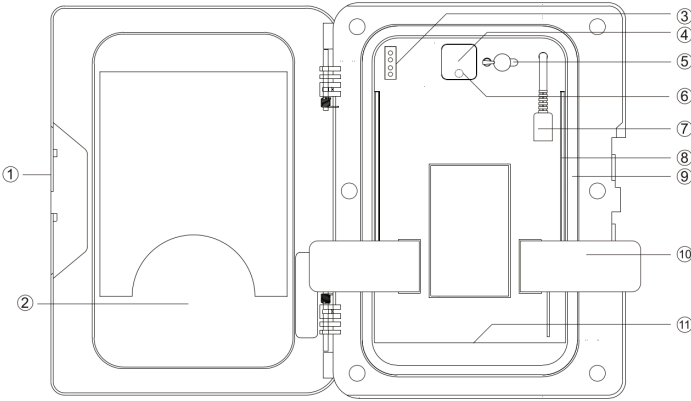

- 1. Open/Close Latch & Protective Door
- 2. Door Control Keypad
- 3. LED Mode Indicator
- 4. Power On/Standby LED
- 5. 3.5mm Aux Input for MP3 device
- 6. Power ON/OFF LED
- 7. USB Connector
- 8. Back lighting
- 9. Water/Dust Protection Gasket
- 10. Security Strap for digital media devices
- 11. Charging Compartment for Remote Control

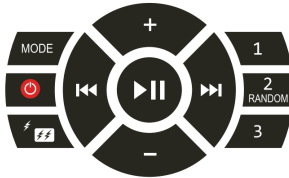

Buttons	AUX IN Mode	Bluetooth Mode	USB Mode	FM Radio
Mode	Press once: Change the source Press and hold: no function			
Power	Press once: Toggle Operational mode to Standby mode or vice versa			
Mode	Press once: External Trigger 1 * Press and hold: External Trigger 2 *			
Volume Up	Press once: Volume up Press and hold: Fast volume up			
Volume Down	Press once: Volume down Press and hold: Fast volume down			
Fast Forward	Press once: no function Press and hold: no function	Press once: Next track Press and hold: Fast Forward		Press once: + 0.05kHz Press and hold: Scan up
Fast Rewind	Press once: no function Press and hold: no function	Press once: Previous track Press and hold: Fast backward		Press once: -0.05kHz Press and hold: Scan down
Play/Pause	Press once: Toggle mute Press and hold: no function	Press once: Play/Pause Press and hold: no function		Press once: Toggle mute Press and hold: no function
1	Press once: no function Press and hold: no function		Press once: Folder up Press and hold: no function	Press once: Preset 1 Press and hold: Save to Preset 1
2 / Random	Press once: no function Press and hold: no function		Press once: no function Press and hold: Random	Press once: Preset 2 Press and hold: Save to Preset 2
3	Press once: Toggle mute Press and hold: no function		Press once: Folder down Press and hold: no function	Press once: Preset 3 Press and hold: Save to Preset 3



Buttons	AUX IN Mode	Bluetooth Mode	USB Mode	FM Radio
Power	Press once: Toggle Operational mode to Standby mode or vice versa			
Mode/Pair	Press once: Change the source Press and hold: no function			
Volume Up	Press once: Volume up Press and hold: Fast volume up			
Volume Down	Press once: Volume down Press and hold: Fast volume down			
Fast Forward	Press once: no function Press and hold: no function	Press once: Next track Press and hold: Fast Forward		Press once: + 0.05kHz Press and hold: Scan up
Fast Rewind	Press once: no function Press and hold: no function	Press once: Previous track Press and hold: Fast backward		Press once: -0.05kHz Press and hold: Scan down
Play/Pause	Press once: Toggle mute Press and hold: no function	Press once: Play/Pause Press and hold: no function		Press once: Toggle mute Press and hold: no function
1	Press once: no function Press and hold: no function		Press once: Folder up Press and hold: no function	Press once: Preset 1 Press and hold: Save to Preset 1
2	Press once: no function Press and hold: no function		Press once: no function Press and hold: Random	Press once: Preset 2 Press and hold: Save to Preset 2
3	Press once: Toggle mute Press and hold: no function		Press once: Folder down Press and hold: no function	Press once: Preset 3 Press and hold: Save to Preset 3
EXT Trigger	Press once: External Trigger 1 Press and hold: External Trigger 2			
Audio	Press once: Enter Audio Menu Press and hold: Ext Audio Menu			
VBass	Press once: Toggle VBass ON or OFF Press and hold: no function			

**POWER ON**

Press the ON/OFF button.

**Red Light:** Power to the docking station is ON, but the unit is in standby mode.

**Blue Light:** The unit is powered ON and looking for an audio source.

**HANDHELD REMOTE CONTROL CHARGING**

The remote has a built-in Polymer Lithium rechargeable battery and comes with a charging cable. Connect one end of the charging cable to the charging connection on remote control and connect the USB end of the charging cable to any USB charger (5V DC) for charging.

Make sure the remote has been charged before used.

**HANDHELD REMOTE CONTROL SYNCHRONIZING**

The remote should already be paired from the factory, but if you need to synchronize the remote, follow the steps below.

1. Make sure Digital Media Locker is powered ON (red LED) the place the remote within 0.5 meter of the Digital Media Locker.
2. Press and hold MODE on remote control until the LCD shows "Pairing in Progress". Release the button.
3. Within 2 seconds, the LCD will show "Paired". If it fails to pair, the LCD will show "Retry again". If this happens, wait 5 seconds and repeat steps above.

**LISTENING VIA USB**

1. Attach your USB thumb drive or devices USB cable to the female USB socket of the Digital Media Locker.
2. Press MODE to select USB mode.
3. Press PLAY to play or pause the music.
4. Press FAST REWIND / FAST FORWARD once play previous / next song file.
5. Press and hold FAST REWIND / FAST FORWARD to fast forward / fast rewind the song file.

## AQ-DM-6UBT—DIGITAL MEDIA LOCKER

### LISTENING VIA BLUETOOTH DEVICE

1. Bluetooth mode will be activated once a Bluetooth device is paired in any mode. Use MODE to change to the Bluetooth mode to listen to music.
2. Play the song from device and the sound will play through the Digital Media Locker.
3. Press PLAY/PAUSE to play/pause the song.
4. Press FAST REWIND/FORWARD buttons to play previous/next song file.
4. Press and hold FAST REWIND/FORWARD buttons to fast forward / fast rewind the song file.
5. Previous/next track and volume up/down can be controlled directly from your Bluetooth device or directly from the Digital Media Locker remote control.

### BLUETOOTH MULTI-LINK

A second Bluetooth device can pair to the Digital Media Locker even when it has been paired to another Bluetooth device. The second Bluetooth device will be able to play once the first device has stopped playing.

### LISTENING TO FM RADIO

Press MODE on remote control to switch to FM radio mode.

#### Scan or Seek FM Radio Channels

1. Press FAST REWIND or FAST FORWARD to seek another station.
2. Press and hold either FAST REWIND or FAST FORWARD for manual tuning back or forward.

#### Saving Radio Channel to Memory

To save the current frequency into memory, press and hold 1, 2 or 3 for more than 2 seconds. The station will be stored into relevant button.

#### Listening to Saved Radio Memory

Press the 1, 2 or 3 preset button once to listen to the station stored in that button.

## DEL OZONE OPERATION MANUAL

- Ozone will turn on during the programmed filter cycles and pump# 1 operation.
- Verify that the green light on the Ozone turns on when activated.
- Check the spa drain (at the bottom of the spa) to verify that small ozone bubbles are coming out.
- Verify that one way check valve is installed on the ozone tubing and it is working as intended.







*Thank you for choosing us!*

At Coast Spas Manufacturing we live by the founding mantra, "Quality shall, in every case, take precedence over quantity." You can rest easy knowing you chose to trust in a brand that is ISO 9001: 2015 quality certified. We build our spas with only the highest quality components available to endure the most extreme conditions.

Hoping you, your family and your friends all enjoy your new spa for years to come.

Sincerely,

A handwritten signature in black ink, appearing to read "Patricia Diamente".

Patricia Diamente, CEO & President